

logitech®

# VIDEO COLLABORATION SOLUTIONS



# TABLE OF CONTENTS

## OVERVIEW

3 Logitech Video Collaboration Group Portfolio

## TEAM COLLABORATION

- 4 Huddle Rooms
- 6 Medium and Large Meeting Rooms
- 10 Multipurpose Rooms
- 12 Room Solutions<sup>1</sup>

## PERSONAL COLLABORATION

- 17 Desktop Solutions

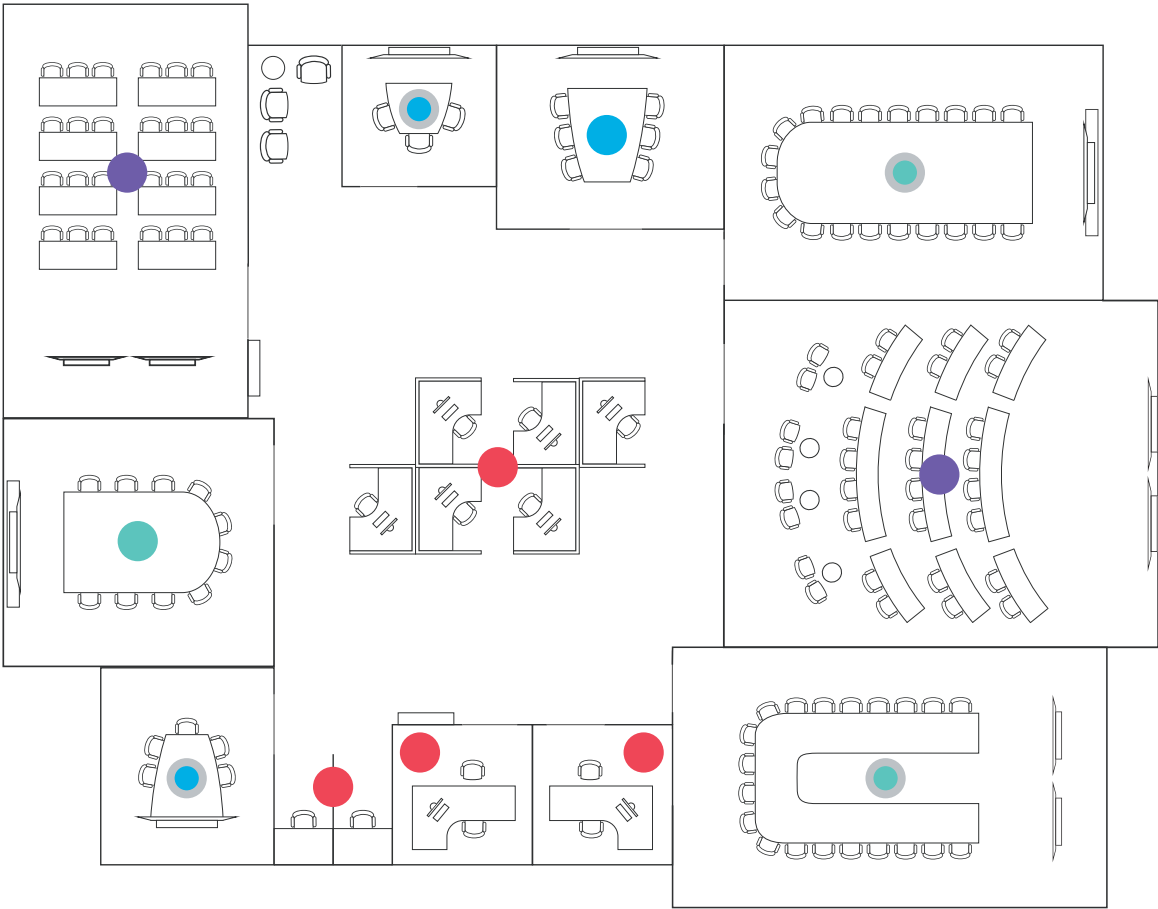

## OVERVIEW

# LOGITECH VIDEO COLLABORATION PORTFOLIO



## ENHANCE COLLABORATION

A good meeting is more than just a perfect presentation. It's about connecting with the people you're engaging with.

Logitech® is transforming the way teams collaborate – opening up new possibilities and eliminating old boundaries with innovative, beautifully designed video collaboration solutions that are amazingly affordable, and fit every room shape or size.

The Logitech ConferenceCam lineup provides both razor sharp video and crystal clear audio – making any meeting place a video collaboration space. Logitech webcams enhance desktop collaboration with high quality HD video, while USB headsets deliver sound that's crisp and clear.

Plus, Logitech Video Collaboration solutions are easy to deploy and use with any video conferencing software application – including the ones you already use.<sup>2</sup>

With forward-thinking vision, Logitech innovates continuously to bring together the latest advancements in technology with customer-centric design. Logitech RightSense™ proactive technologies enable a near effortless video meeting experience where everyone can be seen and heard.<sup>3</sup> With Logitech RightSight™ camera control to frame in participants, Logitech RightLight™ optimization for more natural-looking faces, and Logitech RightSound™ voice leveling and noise suppression, video meetings are made better automatically.

No matter how or where you collaborate, video meetings are seamless.



## TEAM COLLABORATION

# HUDDLE ROOMS

According to Wainhouse Research survey data<sup>4</sup>, people join video conferences from huddle rooms 40% of the time, more often than from any other location. These rooms have unique requirements for success, including a wide angle lens with pan and tilt to ensure everyone in the room is seen, and built-in audio to save space. Logitech huddle room solutions are optimized for these criteria, helping your business get the most out of these small spaces. Plus, Logitech ConferenceCams are compatible with familiar applications<sup>5</sup>, offering an easy way to collaborate.



# HUDDLE ROOMS

## LOGITECH MEETUP

 UP TO 6 SEATS

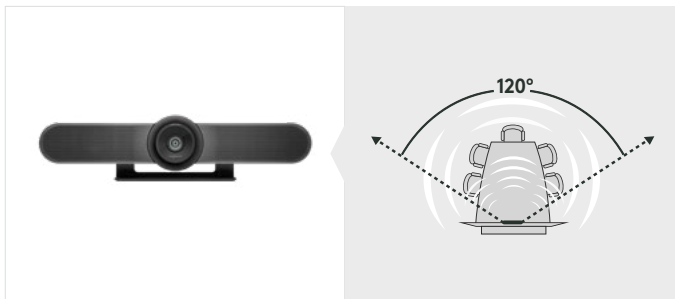

All-in-one ConferenceCam with 120° super-wide field of view, 4K optics<sup>5</sup> and integrated audio. Perfect for huddle rooms.

AMR PART #960-001101

- See everyone, even those close to the camera
- Compact design minimizes cabling and clutter
- Works with your video conferencing applications<sup>5</sup>

### ACCESSORIES FOR MEETUP



#### TV MOUNT FOR MEETUP

Mounting option for MeetUp ConferenceCam.

TV Mount AMR Part #939-001498

TV Mount XL AMR Part #939-001656



#### EXPANSION MIC FOR MEETUP

Add-on microphone for huddle room flexibility.

Extends audio range to 8 seats.

AMR PART #989-000405

## LOGITECH CONNECT

 UP TO 6 SEATS



Portable ConferenceCam with Bluetooth® speakerphone for the huddle room, home office, and on the go.

AMR PART #960-001013

- Superior video and audio with a compact, 3-inch footprint
- Plug-free mobility with a rechargeable battery
- Works with your video conferencing applications<sup>5</sup>

## LOGITECH BCC950

 UP TO 4 SEATS



Desktop video conferencing solution for private offices, home offices, and most any semi-private space.

AMR PART #960-000866

- All-in-one design is easy to use and saves space
- Clear HD video and audio at an affordable price
- Works with your video conferencing applications<sup>5</sup>

TEAM COLLABORATION

# MEDIUM AND LARGE MEETING ROOMS

To get the most out of your medium and large meeting rooms, you need a video conferencing solution that adapts to your space. These meetings rooms are where critical decisions are made, important presentations are executed, and global relationships are built. Logitech offers modular solutions that can be configured to accommodate the shape or layout of your room. And Logitech RightSense technologies make better meetings easy and automatic, ensuring every person in the room can be seen and heard.



# MEDIUM AND LARGE MEETING ROOMS

## LOGITECH RALLY

UP TO 10 SEATS

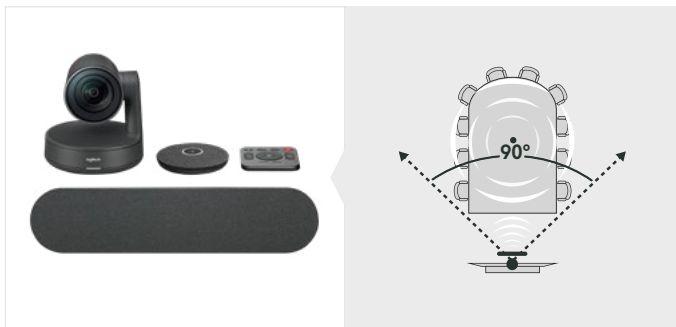

Premium, modular video conferencing system with unmatched video and audio performance for mid-sized rooms. AMR PART #960-001217

- Ultra-HD video with 4K optics<sup>6</sup>
- RightSense technologies with automatic camera control<sup>7</sup>, light and sound optimization<sup>3</sup>
- Modular audio with one front-of-room speaker and one mic pod
- Deploy up to seven total mic pods for extended audio range
- Works with your video conferencing applications<sup>5</sup>

## LOGITECH RALLY PLUS

UP TO 16 SEATS

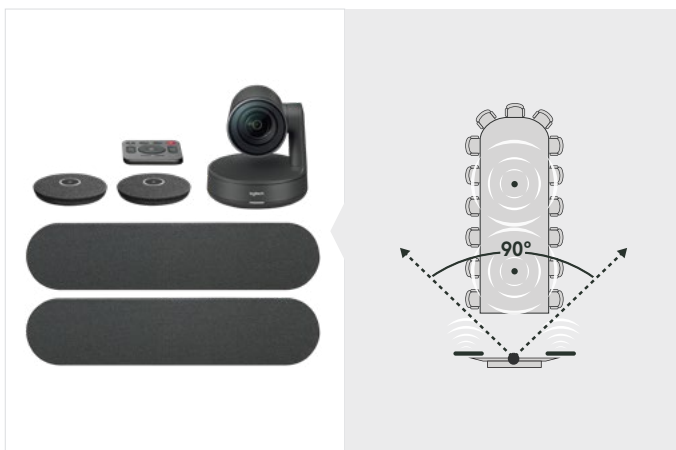

Premium, modular video conferencing system with unmatched video and audio performance. With two speakers and two mic pods, Rally Plus adapts to any room shape or layout. AMR PART #960-001225

- Ultra-HD video with 4K optics<sup>6</sup>
- RightSense technologies with automatic camera control<sup>7</sup>, light and sound optimization<sup>3</sup>
- Modular audio with two front-of-room speakers and two mic pods
- Deploy up to seven total mic pods for extended audio range
- Works with your video conferencing applications<sup>5</sup>

## ACCESSORIES FOR RALLY AND RALLY PLUS



### RALLY MOUNTING KIT

Recommended mounting option for Logitech Rally. AMR PART #939-001644



### RALLY MIC POD

Use up to seven pods. Each additional mic accommodates up to six more seats. AMR PART #989-000430



### RALLY MIC POD HUB

Flexible microphone placement for Logitech Rally and Rally Plus. AMR PART #939-001647



### RALLY SPEAKER

Add a second speaker for larger rooms (included with Rally Plus). AMR PART #960-001230

# MEDIUM AND LARGE MEETING ROOMS

## LOGITECH GROUP

   UP TO 14 SEATS

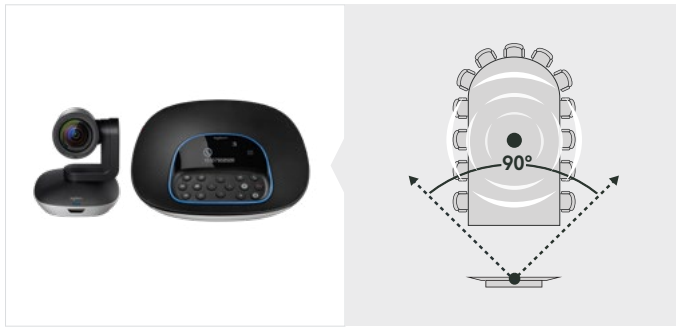

Affordable video conferencing system with HD video, 10x zoom and a tabletop speakerphone.

AMR PART #960-001054

- HD 1080p/30 with 10x lossless zoom<sup>6</sup>
- 90° field of view and motorized pan and tilt
- Beamforming full-duplex speakerphone
- Acoustic echo cancellation and noise reduction technology
- Works with your video conferencing applications<sup>5</sup>

## LOGITECH GROUP WITH EXPANSION MICROPHONES

   UP TO 20 SEATS



Affordable video conferencing system with HD video, 10x zoom, a tabletop speakerphone and two expansion microphones.

AMR PART #960-001060

- HD 1080p/30 with 10x lossless zoom<sup>6</sup>
- 90° field of view and motorized pan and tilt
- Beamforming full-duplex speakerphone
- Acoustic echo cancellation and noise reduction technology
- Two expansion microphones extend audio range
- Works with your video conferencing applications<sup>5</sup>

## ACCESSORIES FOR GROUP



### GROUP EXPANSION MICROPHONES

Includes two omni-directional microphones.  
Extends GROUP audio range to 20 seats.  
AMR PART #989-000171



### GROUP CABLE 10M

10 meter cable for installation in larger rooms.  
AMR PART #939-001487



### GROUP CABLE 15M

15 meter cable for installation in larger rooms.  
AMR PART #939-001490



**ENABLE EVERY ROOM.  
ENABLE EVERY PERSON.**



TEAM COLLABORATION

# MULTIPURPOSE ROOMS

Multipurpose rooms require a versatile camera that can adapt to different uses cases, whether it's as a classroom, a training room or an auditorium. Perfect for bigger spaces with a larger number of participants, Logitech PTZ Cameras can capture an entire space in detail, while still offering the ability to focus on details—like the presenter, panelists, whiteboards or individual participants. Whether it's for a meeting, a seminar, or a presentation, Logitech USB cameras give participants the experience of sitting together in the same room, even if they are a thousand miles away.



# MULTIPURPOSE ROOMS

## LOGITECH RALLY CAMERA

20+ SEATS

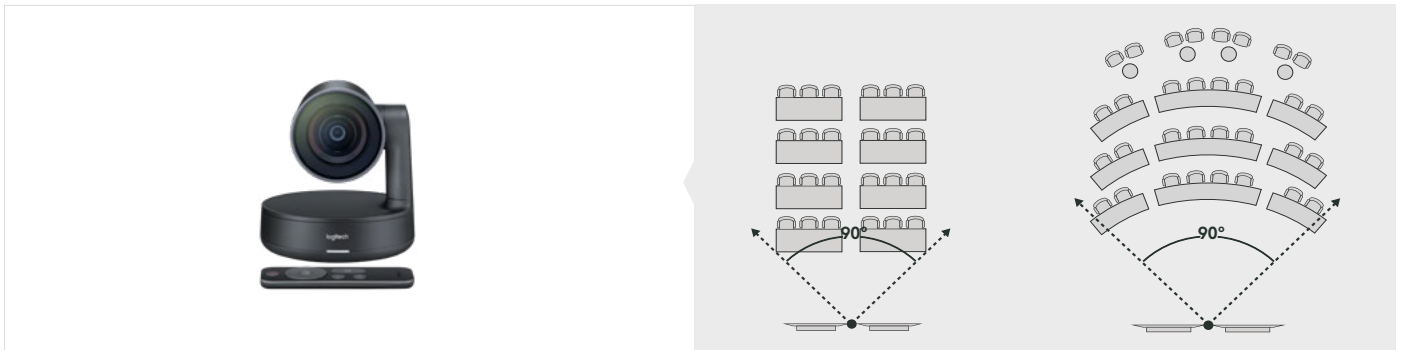

Premium PTZ camera with Ultra-HD imaging and automatic camera control for boardroom-quality video.  
AMR PART #960-001226

- RightSight automatic framing<sup>7</sup> and RightLight automatic light balance and color optimization<sup>3</sup>
- 4K optics with 15x HD zoom<sup>6</sup>
- 90° field of view
- Motorized pan, tilt and zoom
- Works with your video conferencing application<sup>5</sup>

## LOGITECH PTZ PRO 2 CAMERA

20+ SEATS

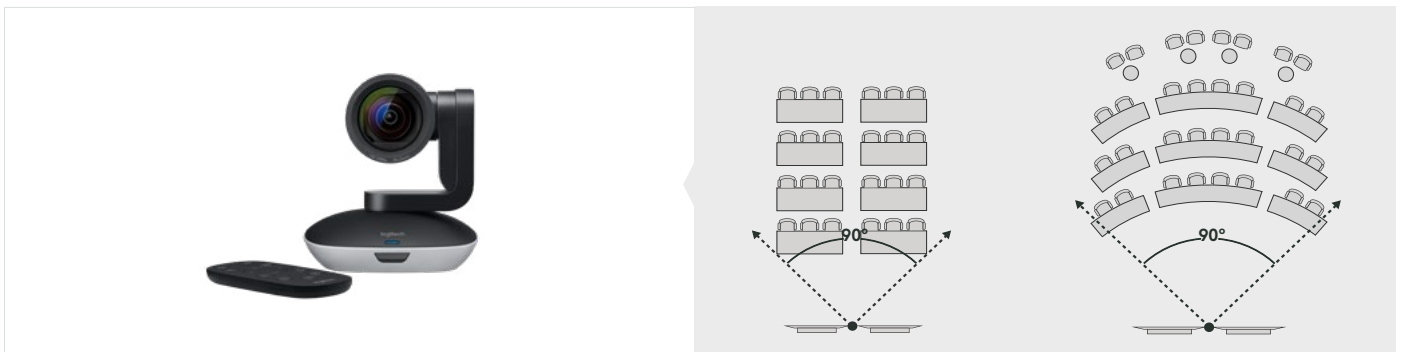

HD video camera with enhanced pan, tilt and zoom.  
AMR PART #960-001184

- HD 1080p30 with 10x lossless zoom<sup>6</sup>
- 90° field of view
- Motorized pan, tilt and zoom
- Works with your video conferencing application<sup>5</sup>

## TEAM COLLABORATION

# ROOM SOLUTIONS

From small huddle rooms to large meeting rooms, room solutions make video collaboration seamless for any business. Participants can walk in and launch their meeting with one touch. This means less training, fewer trouble tickets and better video meetings throughout the workspace. Logitech room solutions offer a consistent collaboration experience, expertly configured for fast deployment and self-service connections to any video conferencing cloud service. Logitech room solutions make hosting and joining a meeting effortless for participants.





# ROOM SOLUTIONS

---

## LOGITECH SMARTDOCK AV CONTROL CONSOLE



AV control console for Skype® Room Systems with one-touch join, streamlining video collaboration and desktop sharing. AMR PART #960-001093

- Securely locks Microsoft® Surface® Pro
- Adds connectivity without clutter including HDMI for dual 1080p displays, three USB ports, Gigabit Ethernet, and headset jack
- Simplifies content sharing with 1080p30 HDMI input and capture

### ACCESSORIES FOR SMARTDOCK



#### SMARTDOCK FLEX\*

Recommended expansion kit that consolidates AV, USB and power to a single CAT6 cable, and adds AV Passthrough for easy guest access to the room's display, camera, and speakerphone. AMR PART #960-001213

- Deploy SmartDock up to 50ft (15m) away from the room's AV equipment
- Adds an HDMI input for wired content sharing

\* Strongly recommended for simplified setup



#### SMARTDOCK EXTENDER BOX

Basic expansion kit that consolidates cross-room cabling to a 5-in-1 proprietary cable (14mm diameter, not routable through standard conduit). AMR PART #960-001095

- 16 ft (5m) cable is sufficient for smaller rooms
- Adds an HDMI input for wired content sharing

## LOGITECH GROUP KIT WITH INTEL NUC



Get everything you need in one box, already optimized for easy connections to any video conferencing bridge or cloud service. Calendar integration and a tabletop touch screen make video meetings one-touch easy. Add-on mics with simple plug and play functionality are available to accommodate larger rooms.

**Contact Reseller for price**

- Everything you need in one box
- Customizable shortcuts to cloud services
- One-touch meeting access

# ROOM SOLUTIONS

---

## LOGITECH MEETUP KIT WITH INTEL NUC



Get everything you need in one box, already optimized for easy connections to any video conferencing bridge or cloud service. Calendar integration and a tabletop touch screen to make video meetings one-touch easy.

**Contact Reseller for price**

- Compact footprint and 5X zoom
- Customizable shortcuts to cloud services
- One-touch meeting access

---

## LOGITECH SCREEN SHARE



Bringing instant and easy content sharing to any conference room computer by simply connecting a laptop or tablet via HDMI.

**AMR PART #939-001553**

- Wired content sharing for conference room computers
- Share from any device with an HDMI-compatible output
- Works with most any meeting or webinar service<sup>5</sup>

# WORK SEAMLESS. WORK SMARTER.



## PERSONAL COLLABORATION

# DESKTOP SOLUTIONS

Making a video call in personal space requires avoiding distractions and staying in control of what viewers can see. Logitech personal collaboration solutions can turn any desktop into an instant collaboration space. With a plug-and-play USB HD webcam and/or headset combination or a mobile hands-free speakerphone, face-to-face desktop collaboration is easy. Premium webcams include RightLight to optimize images for more natural light and color. And all audio solutions provide crystal clear audio with noise-cancelling technology to ensure you can hear and be heard whether you are in an open space or a private office.





# DESKTOP SOLUTIONS

---



## LOGITECH BRIO



Ultra HD webcam for video conferencing, streaming, and recording.  
AMR PART #960-001105

- Spectacular video quality up to 4K
- Look great in any light with HDR and RightLight 3
- Enhanced security with Windows Hello™ facial log-in
- Works with your video conferencing applications<sup>5</sup>



## LOGITECH C930e WEBCAM



Business webcam with a wide field of view and HD digital zoom.  
AMR PART #960-000971

- 1080p HD quality, ideal for video conferencing
- Excellent low-light performance with RightLight 2
- Premium glass lens
- Works with your video conferencing applications<sup>5</sup>

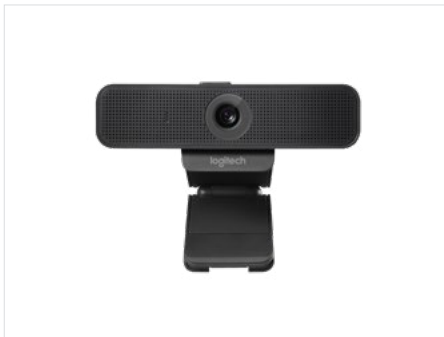

## LOGITECH C925e WEBCAM



Affordable 1080p HD webcam with integrated privacy shade.  
AMR PART #960-001075

- Designed for desktop video conferencing
- RightLight 2 ensures clear video with typical office lighting
- Sliding internal shade assures privacy
- Works with your video conferencing applications<sup>5</sup>



## LOGITECH B525 HD WEBCAM



Ideal for on-the-go professionals with a compact, foldable, 360° swivel design.  
AMR PART #960-000841

- 1080p HD quality in a compact form factor
- Folds for grab-and-go convenience
- 360° swivel so you can point in any direction
- Works with your video conferencing applications<sup>5</sup>

# DESKTOP SOLUTIONS

---



## LOGITECH WIRELESS HEADSET H820e



Wireless headset for increased mobility. Designed for comfort with padded headband and soft replaceable ear pads.

Dual: AMR PART #981-000516, Mono: AMR PART #981-000511

- Up to 300-foot range
- Up to 10 hours of talk time
- Noise-cancelling technology
- Works with your video conferencing applications<sup>5</sup>



## LOGITECH USB HEADSET H650e



Wired headset with clear audio, acoustic echo cancellation, and a noise-cancelling boom mic.

Dual: AMR PART #981-000518, Mono: AMR PART #981-000513

- Tactile and intuitive controls
- Enterprise-grade audio quality
- Designed and certified for business
- Works with your video conferencing applications<sup>5</sup>

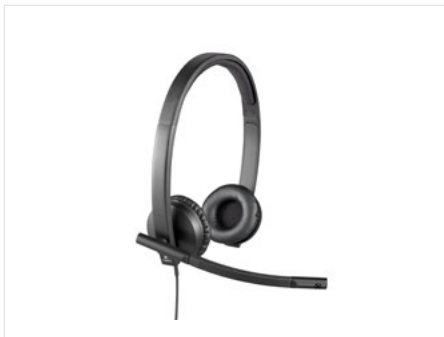

## LOGITECH USB HEADSET H570e



Easy-to-use add wired headset for all-day comfort and productivity.

Dual: AMR PART #981-000516, Mono: AMR PART #981-000511

- Strong and light for long-term comfort
- Easy-to-find inline controls
- Clear audio at a great price
- Works with your video conferencing applications<sup>5</sup>

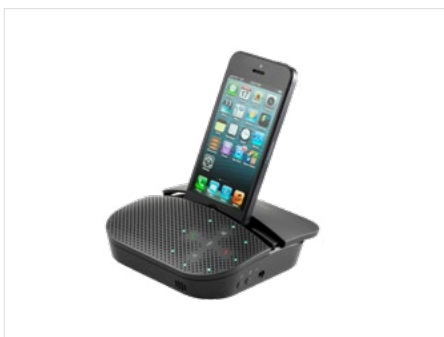

## LOGITECH MOBILE SPEAKERPHONE P710e



Hands-free calling and audio with noise-cancelling technology for your phone or tablet. Pair Bluetooth devices or connect with NFC by simply touching a device to the P710e.

AMR PART #980-000741

- Works with most any computer or mobile device
- Go cordless with up to 15 hours of talk time
- Integrated stand for smartphones and tablets

# VIDEO MEETINGS. ANYTIME. ANYWHERE.



# LEARN MORE ABOUT LOGITECH COLLABORATION SOLUTIONS.

Visit [www.logitech.com/vcresourcecenter](http://www.logitech.com/vcresourcecenter)

Or contact your  
Logitech representative at:

Kim Haymaker  
[khaymaker@logitech.com](mailto:khaymaker@logitech.com)  
(415) 375-5178

## CONNECTIVITY



USB plug-and-play



Bluetooth wireless  
technology



Near Field Communication  
technology

## NOTES

<sup>1</sup> Complete room solutions from Logitech allow participants to quickly kick off and run a video conference meeting.

<sup>2</sup> Refer to [www.logitech.com/lcp](http://www.logitech.com/lcp) for current list of Logitech Collaboration Program participants.

<sup>3</sup> RightSense technologies vary by product and software version. Please refer to the specifications for your Logitech device and install the latest firmware for best performance.

<sup>4</sup> <https://www.logitech.com/en-us/video-collaboration/resources/think-tank/infographics/the-huddle-room-meeting-experience.html>

<sup>5</sup> Logitech ConferenceCams and Webcams are certified and/or compatible with Microsoft Skype® For Business, Microsoft Teams, Google® Hangouts™ Meet, Zoom, BlueJeans, GoToMeeting®, WebEx™, and other video conferencing, streaming, and recording applications that support USB cameras and audio devices. Please visit our product pages on [www.logitech.com/vc](http://www.logitech.com/vc) for more information.

<sup>6</sup> Supported video modes vary by application.

<sup>7</sup> RightSight is enabled by a software download with initial support for Windows® 10. Please see [www.logitech.com/rightsight](http://www.logitech.com/rightsight) for availability.

Published November 2018

© 2018 Logitech. Logitech, the Logitech logo and other Logitech marks are owned by Logitech and may be registered. All other trademarks are the property of their respective owners. Logitech assumes no responsibility for any errors that may appear in this publication. Product, pricing and feature information contained herein is subject to change without notice.

**logitech**®